

ESL100W

Magnetic Non Dimmable MT

Outdoor Stainless Steel Enclosure

Multi Tap: **12VAC and 15VAC**

Total Wattage: **100W max**

Input Voltage: **120V 60Hz**



Conforms to UL STD. 1838
Certified to CSA
STD. C22.2 No 250.0, 250.7

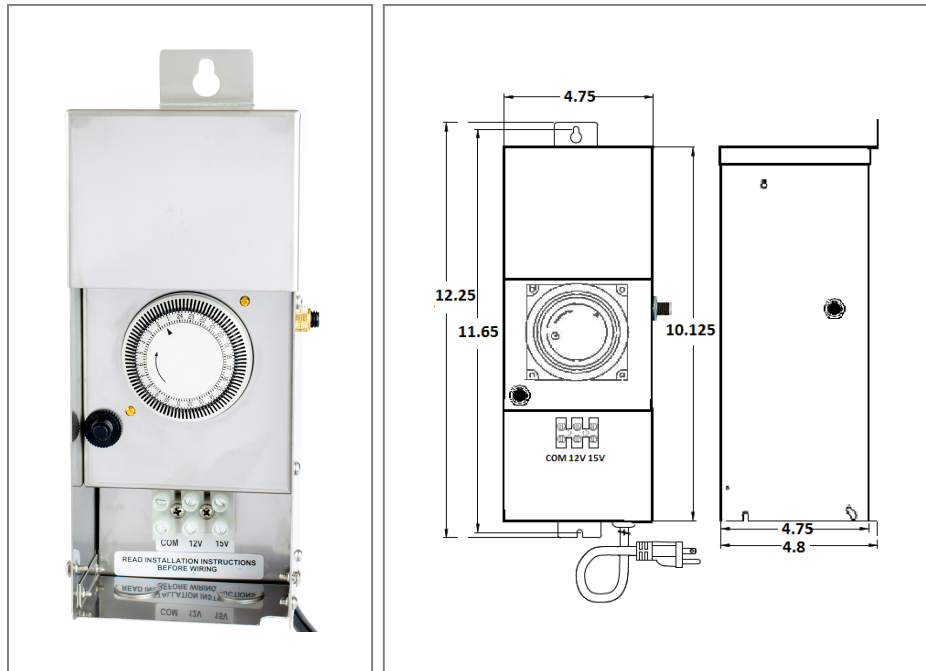

Transformer

Non dimmable if use timer or/and photocell
Temperature class B(130°C)
Thermal manually reset secondary breaker 15A
Timer and photocell build in options

Housing

The actual transformer 100W is encapsulated in the enclosure
The enclosure is Stainless Steel, NEMA 3R rated
Wiring compartment has 2 knockouts sizes for 3/8 inch screw cable connectors
Enclosure Temperature does not exceed 65°C at 45°C ambient and fully loaded
Dimensions (inch): H = 12.25, W = 4.75, D = 4.8
Weight (LBs): 9

Electrical Parameters

Input Voltage: **120V 60Hz**

Max. input current at full load: **1A**

Output voltage without load: **12/ 15VAC**

Output voltage fully loaded: **11.5/ 14.5VAC**

Max. Total Wattage: **100W**

Max. Output Current: **8.3/ 6.6A**

Efficiency: **90%**

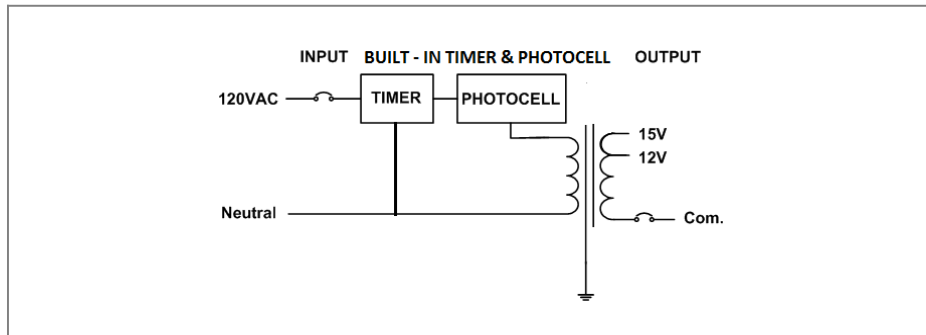

Mailing Address: 646 Flinn Ave. Unit B, Moorpark , CA 93021 Tech support: Arik Nirenberg phone: 818-904-3309
Fax: 818 904 3327 info@emcod.com techsupport@emcod.com